

The Classics ®

manufactured by



Visit our site on the World Wide Web

*<http://www.whites.co.com>
for the latest information on products, services, local dealers
and treasure hunting news.*

Guide to this Manual

Assembly	3
Batteries	4
CLASSIC @ I	5
Operating Instructions	6
Disc (Discrimination) Control	7
CLASSIC @ II	9
Operating Instructions	10
SENS (Sensitivity or Gain) Control	11
Disc (Discrimination) Control	11
ALL METAL Toggle Control	11
CLASSIC @ III	13
Operating Instructions	14
SENS (Sensitivity or Gain) Control	15
Disc (Discrimination) Control	16
GEB/DISC Toggle	16
FREQ ADJ (Frequency Adjustment)	16
NORMAL/BLACK SAND Toggle	17
TECHNIQUES	19
Search Methods	20
Headphones	22
Proper Care of Your Detector	22
Advanced Operators	24
Glossary of Terms	26
Authorized Service Centers	29
Warranty	30
Warranty Transfer	31

To Assemble:

I. Remove all parts from shipping carton and check the assembly page to make sure parts are present.

II. There are rubber washers between clevis/lower rod and loop ears. Use only nonmetallic washers, fiber bolt, and thumbnut to secure loop to clevis/lower rod.

III. Unlock "S" rod camlock and insert clevis/lower rod into curved "S" rod so that stainless steel spring clip buttons line up and lock into one of the adjustment holes in the curved "S" rod. Turn camlock to secure.

IV. Unravel loop cable and wind the cable around the clevis and rod assembly, first revolution over the top of the rod. Wind cable all the way to the top of the curved "S" rod, about five revolutions. Plug loop connector into control box and screw finger tight to secure.

V. Grip the instrument by the handle, with your arm in the elbow cup, and sweep the loop over the floor. If the instrument fit feels uncomfortable, adjust the elbow cup by removing and repositioning the bolt/thumbnut and installing in one of the optional positions. If necessary, readjust clevis/lower rod position.

VI. Adjust the elbow cup strap so that it is loose enough for you to slide your arm in and out without loosening each time you want to set the detector down.

VII. Remove protective paper from the black elbow cup foam pads, carefully align each in the elbow cup and press firmly into place.

VIII. Install battery as described in the next section, decal facing down, with plastic tab and steel contacts facing toward inside of battery compartment.

IX. It should be noted at this point that the detector may not work as expected indoors due to the high degree of metals used in modern construction. It is best to tune and practice out-of-doors to ensure stable, predictable results.

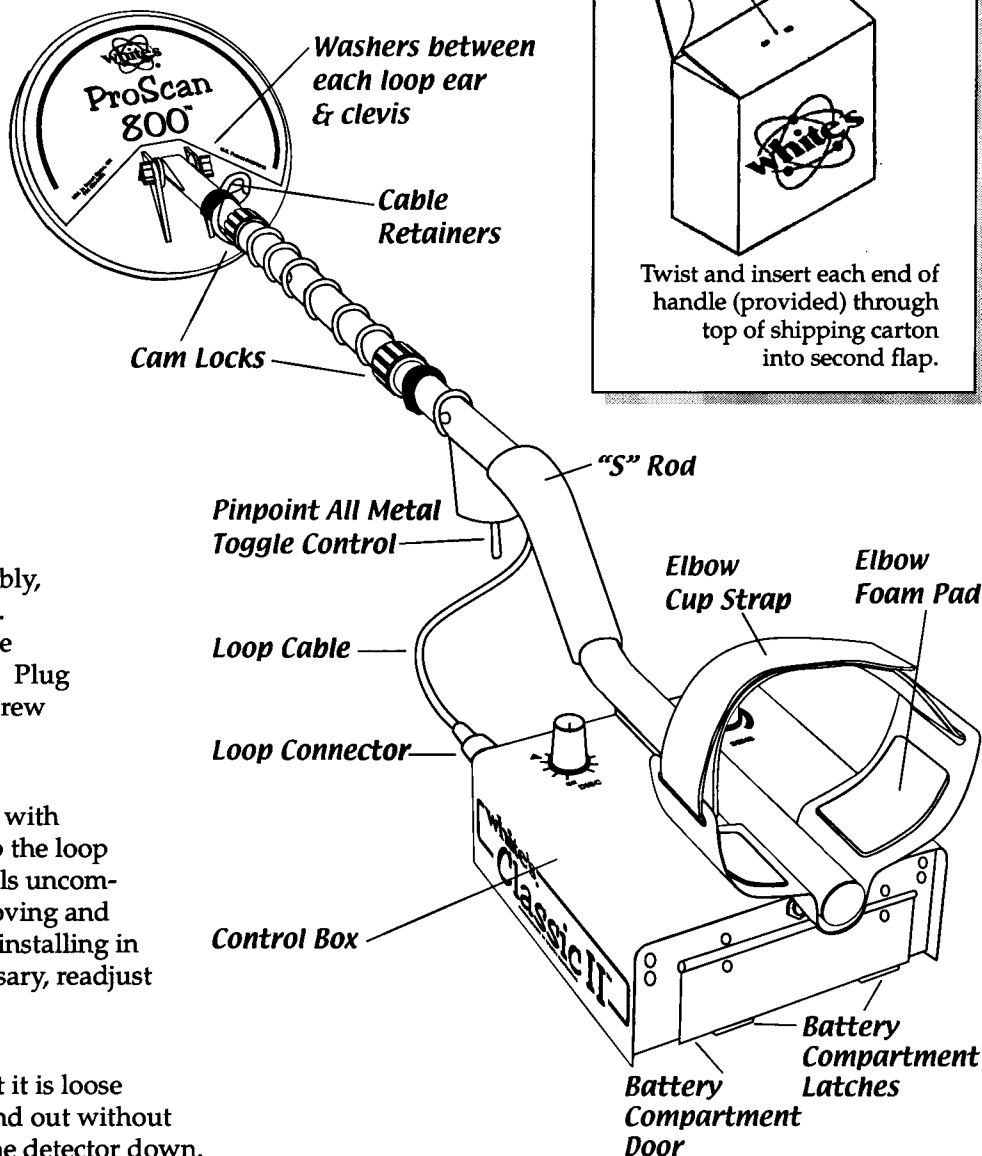

Batteries

I. Standard Batteries:

A. The standard battery holder holds eight "AA" cell batteries. Alkalines are recommended for use with this model. During normal searching conditions you can expect about 50 hours of hunting time from one set of eight Alkalines.

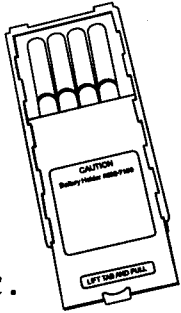

C. Once the batteries become weak, the beep over metal targets will be reduced in volume. Shortly thereafter, the instrument will no longer respond to metals.

B. Non-alkalines can be used in this holder. When non-alkalines or rechargeable "AA" cells are used detecting time (before replacement/recharge) will be reduced to about 40 hours.

D. The battery compartment opens by gently pulling down on the front of each of the two latches on the bottom of the control box.

II. Using The Standard Battery Holder:

A. Slide open the battery holder lid (decal side of battery holder) by applying gentle upward pressure on the tab of the door so that it unlocks. Slide the door away from the battery box exposing the cell positions.

B. Remove any old cells from the holder. Note the (+) and (-) positions of each cell and the (+) and (-) for each position marked inside the cell tray. Install new "AA" cells noting carefully the correct (+) and (-) positions.

1. If the cells are installed incorrectly, the detector may require service by an Authorized Service Center.

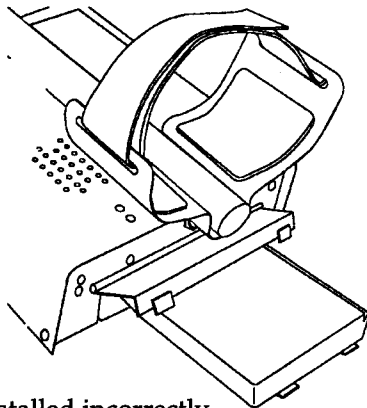

C. Slide the door closed so that it snaps securely.

D. Insert the battery holder into the detector so that the decal is facing down, with the battery holder door tab and metal contact points facing toward the inside of the battery compartment.

1. Close the battery compartment door and secure the two latches on the bottom of the case. Hook the front of each latch first, then press down on the rear.

III. Rechargeable Batteries:

A. White's manufactures an optional rechargeable battery system for this model. The latest state-of-the-art non-memory characteristics. Please contact your Dealer or White's directly for more information.

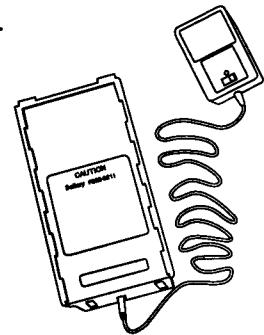



Attention:

To use your Classic® I in average conditions, set the ON/OFF DISC knob to the RING RANGE "P" position.

The loop must be in continuous motion (moving from side to side) in order for this model to respond to metals. If the loop is held stationary, metal may not respond.

A good metal (coin) will produce a smooth, consistent, solid sounding, "BEEP".
A trash metal (nail or steel bottle cap) will produce no sound or a rough, inconsistent, click or flutter-sounding "BEEP".

Pinpoint metals exact location by slowly "X-ing" the loop over the area and "eyeballing" the center. The detector will "BEEP" as the physical center of the loop passes the center of the target.

**C
l
a
s
s
i
c

I**

Operating Instructions - Classic® I

I. Once fully assembled, and the batteries installed, set the ON/OFF DISC knob to Ring Range "P" (Preset).

A. The Ring Range "P" (Preset) is recommended for most general purpose searching. At this position the detector will reject most iron and light foil, and respond to most valuables including jewelry.

1. Positions lower (counterclockwise) than Ring Range provide even less trash metal rejection, to the point of detecting virtually all types of common metals except small iron and small stainless steel.

B. The Coin Range "P" (Preset) is optional. At this position the detector will reject more trash metals including aluminum pulltabs. However, nickels and some jewelry will also be rejected.

1. Positions higher (clockwise) than the Coin Range will provide even greater degrees of trash metal rejection.

C. The most useful range on this control is between the Ring Range and Coin Range positions. If when searching at the Ring Range position you feel you are digging too much trash, adjust slightly toward the Coin Range and try again. Finding the lowest (furthest counterclockwise) position that eliminates the common trash metals in your area is important in order to find items of jewelry.

D. When a trash metal is being rejected, it will produce a shorter sounding beep that is typically inconsistent, a click, or flutter-sounding beep. When a good metal is accepted it will produce a consistent, smooth, solid, and longer sounding beep. Some trash metals, such as larger pieces of lead, brass, aluminum, or tin, will produce a good sound regardless of the DISC control position.

II. Once either Ring Range "P" or Coin Range "P" has been selected, sweep the round loop close to the ground passing it from side to side. The loop must be swept (in motion) for metals to respond and provide accurate discrimination. Each pass of the loop from left to right (or from right to left) should take about two seconds. If the loop is swept very, very slowly, or is stopped, the detector may not respond to metal.

III. At this point, it is a good idea to find an area relatively free of metal to practice. Place a coin on the ground. Pass the loop over the coin. Note that some loop movement is necessary to receive a good clean sound. Note that if you sweep the loop too slow the coin doesn't respond well.

IV. Now place a large nail, and/or a steel bottle cap (not aluminum) on the ground. Sweep the loop over these metals. Note the inconsistency in the beep, and that it is a shorter click or has a flutter to the sound. An operator will soon learn to ignore the clicks or flutter sounds junk produces and listen for the smooth consistent beep coins and other good metals produce.

V. Once a smooth consistent beep has been located, pinpoint exactly where to dig by "X-ing" the loop slowly over the area, and "eyeballing" the center. The detector will "beep" as the physical center of the loop passes the center of the target. Note that some loop movement is required. It is a good idea to place coins on the ground and practice pinpointing. It takes some time to develop pinpointing skills.

Discrimination Control - Classic® I

The DISC (discrimination) control selects the amount of rejection against trash metals. At its fully counterclockwise position the detector is turned OFF for periods of non-use. As soon as it is turned clockwise the control clicks indicating the detector is ON, and at its minimum amount of discrimination against trash metals. Most common metals are detected at this setting except for small iron and small stainless steel. As the Disc knob is turned clockwise, more and more trash rejection is achieved until the fully clockwise setting. At the fully clockwise setting, nearly all trash metals are rejected as well as some valuables.

Some larger items, such as lead, aluminum and tin will still respond.

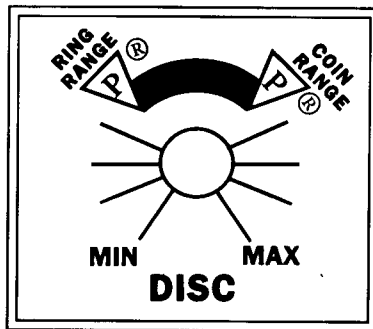

An operator of the Classic® I may want to adjust the DISC control for several reasons:

- I. Minimum trash rejection is needed for detecting iron and steel such as tools, horseshoes, relics, property stakes. Iron and steels are rejected quickly as the DISC control is turned clockwise.
- II. For the rejection of most common trash metals and the detection of most valuables the highest DISC control setting that still responds to a USA nickel is ideal. This should occur somewhere near the RING RANGE "P" .
- III. For the rejection of all trash metals, even though some valuables will also be lost, higher rejection levels are useful. Some areas of severe trash can easily be searched for silver coins at high DISC settings. Nickels and small to medium gold items will not be detected.

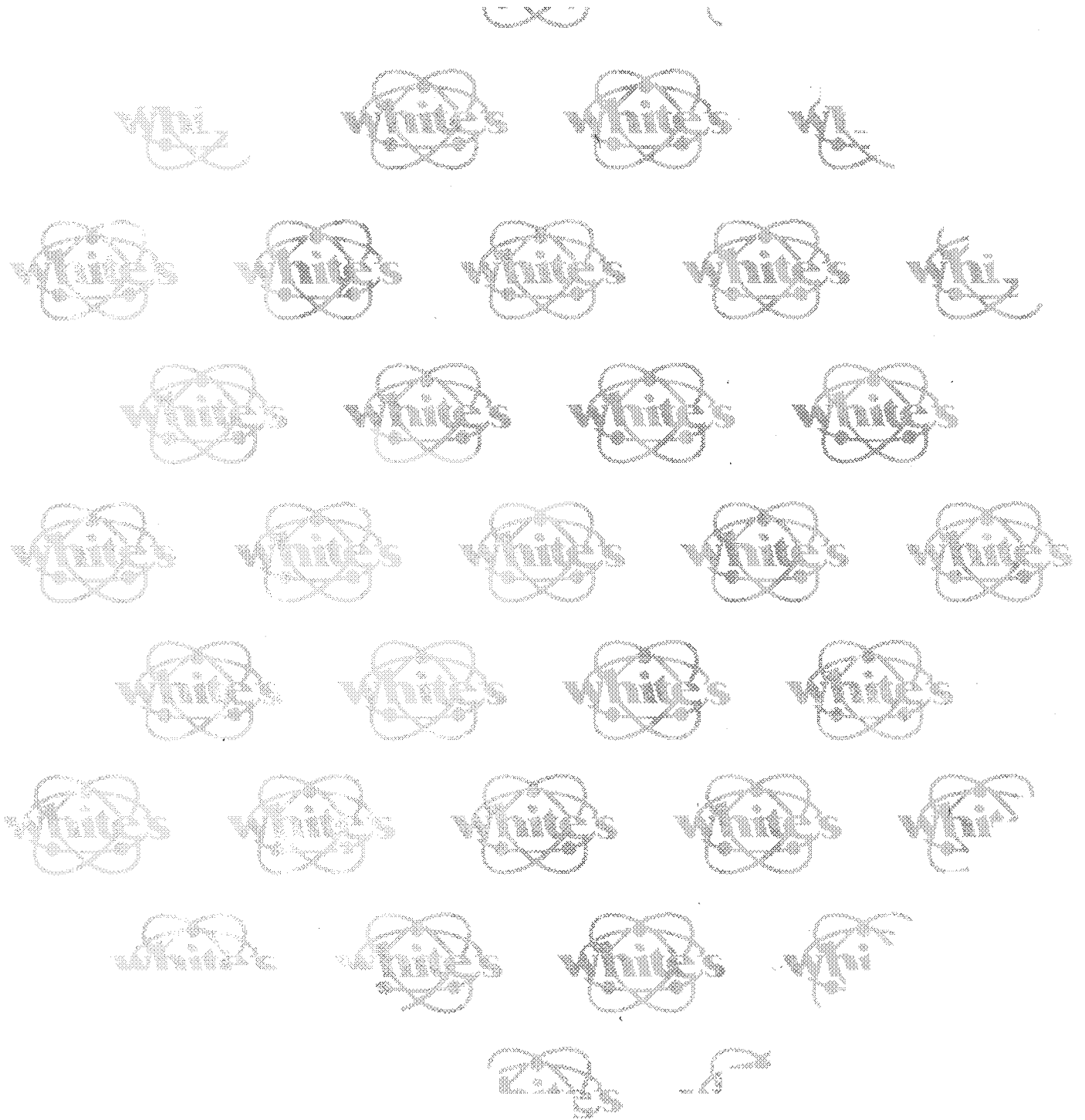



Attention:

To use your Classic® II in average conditions, set the ON/OFF SENS knob to the "P" position, set the DISC knob to the RING RANGE "P" (Preset) position, and set the ALL METAL toggle (located on the handle/rod) to the center DISC position.

The loop must be in continuous motion (moving from side to side) in order for this model to respond to metals. If the loop is held stationary, metal may not respond.

A good metal (coin) will produce a smooth, consistent, solid sounding "BEEP". A trash metal (nail or steel bottle cap) will produce a rough, inconsistent, click or flutter-sounding "BEEP".

Pinpoint metals exact location by squeezing and holding the ALL METAL toggle in the temporary position and then slowly "X-ing" the loop over the area "eyeballing" the center. The detector will "BEEP" as the physical center of the loop passes the center of the target. Release the ALL METAL toggle so that it returns to the center DISC position before continuing to search.

**C
l
a
s
s
i
c

II**

Operating Instructions - Classic® II

I. Once fully assembled, and the batteries installed, set the ON/OFF SENS knob to the "P" (Preset) position set the DISC knob to the RING RANGE "P" (Preset) position and set the ALL METAL toggle (located on the handle/rod) to the center DISC position.

II. The SENS (Sensitivity) knob turns the instrument ON/OFF and adjusts the responsiveness of the detector to metal targets as well as interference from external electrical sources and ground peculiarities.

A. In most conditions the "P" (Preset) position is ideal.

1. If interference becomes apparent (false signals or instability) reduce the SENS control (counter-clockwise) until smooth, stable operation is restored.

2. If smooth, stable operation is noted at "P" (Preset), increasing the SENS control (clockwise) may increase detection depth so long as the ground is not extremely mineralized.

3. When not in use, turn the SENS (Sensitivity) knob fully counter clockwise until it clicks indicating the instrument is turned OFF.

III. The DISC (Discrimination) knob adjusts the level of rejection against trash metals.

A. The Ring Range "P" (Preset) is recommended for most general purpose searching. In this position, the detector will reject most iron and light foil and respond to most valuables including jewelry.

1. Positions lower (counterclockwise) than Ring Range provide even less trash metal rejection, to the point of detecting virtually all types of common metals except small iron and small stainless steel.

B. The Coin Range "P" (Preset) is optional. In this position, the detector will reject more trash metals including aluminum pulltabs. However, nickels and some jewelry will also be rejected.

1. Positions higher (clockwise) than the Coin Range will provide even greater degrees of trash metal rejection.

C. The most useful range on this control is between the Ring Range "P" and Coin Range "P" positions. If when searching at the Ring Range position you feel you are digging too much trash, adjust slightly toward the Coin Range and try again. Finding the lowest (furthest counter clockwise) position that eliminates the common trash metals in your area is important in order to find items of jewelry.

D. When a trash metal is being rejected, it will produce a shorter sounding beep that is typically inconsistent, a click or flutter-sounding beep. When a good metal is accepted it will produce a consistent, smooth, solid, and longer sounding beep. Some trash metals, such as larger pieces of lead, brass, aluminum or tin will produce a good sound regardless of the DISC control position.

IV. Once either Ring Range "P" or Coin Range "P" has been selected, sweep the round loop close to the ground passing it from side to side. The loop must be swept (in motion) for metals to respond and provide accurate discrimination. Each pass of the loop from left to right (or from right to left) should take about two seconds. If the loop is swept very very slowly or is stopped, the detector may not respond to metal.

V. At this point, it is a good idea to find an area relatively free of metal to practice. Place a coin on the ground. Pass the loop over the coin. Note that some loop movement is necessary to receive a good clean sound. Note that if you sweep the loop too slow the coin doesn't respond well.

VI. Now place a large nail, and/or a steel bottle cap (not aluminum) on the ground. Sweep the loop over these metals. Note the inconsistency in the beep, and that it is a shorter click or has a flutter to the sound. An operator will soon learn to ignore the clicks or flutter sounds junk produces and listen for the smooth consistent beep coins and other good metals produce.

VII. Once a smooth consistent beep has been located, pinpoint exactly where to dig by squeezing and holding the ALL METAL toggle in the temporary position and "X-ing" the loop slowly over the area "eyeballing" the center. The detector will "beep" as the physical center

as the loop passes the center of the target. Note that some loop movement is required. It is a good idea to place coins on the ground and practice pinpointing. It takes some time to develop pinpointing skills. Release the ALL METAL toggle and it will automatically return to the DISC position before continuing to search.

VIII. If the desire is to detect iron/steel such as tools, relics or property stakes, place the ALL METAL toggle in the forward LOCK position and leave it there during searching. With the ALL METAL toggle in the forward LOCK position, all types of common metals respond.

Sensitivity/Gain Control

The Sensitivity knob turns the instrument ON and OFF and adjusts the responsiveness of the instrument. As the SENS knob is turned further and further clockwise, detection depth as well as sensitivity to physically small metal items increases. Unfortunately, external electrical interference and ground interference also increases. The best setting is the furthest clockwise position that provides smooth, stable and predictable results.

An operator of the Classic® II may want to adjust the SENS knob for several reasons:

- I. Minimum sensitivity is needed for detecting near power lines, electric fences, microwave antennas, etc.
- II. For good results in most conditions the "P" (Preset) position works well.

III. If the "P" (Preset) position works well (smooth, stable and predictable results) increasing the SENS knob clockwise will increase detection depth so long as the ground is not extremely mineralized.

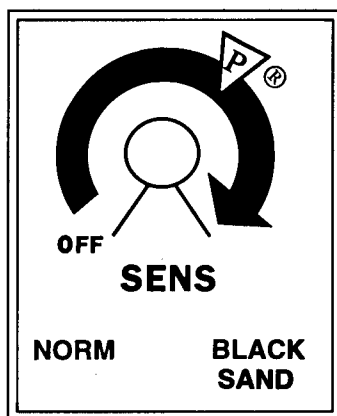

Discrimination Control

The DISC (discrimination) control selects the amount of rejection against trash metals. At the fully counter-clockwise position it has the minimum amount of discrimination against trash metals. Most common metals are detected at this setting except for small iron and small stainless steel. As the DISC knob is turned clockwise, more and more trash rejection is achieved. At the fully clockwise setting nearly all trash metals are rejected, as well as some valuables. Some larger items, such as lead, aluminum and tin will respond regardless of the DISC control setting.

An operator of the Classic® II may want to adjust the DISC control for several reasons:

I. Minimum trash rejection is needed for detecting iron and steel such as tools, horseshoes, relics and property stakes. Iron and steels are rejected quickly as the DISC control is turned clockwise.

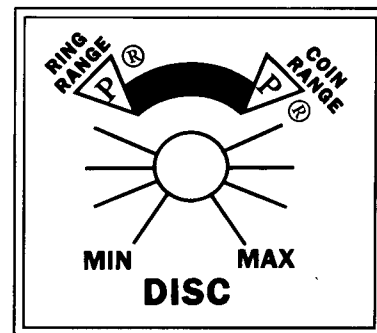

II. For the rejection of most common trash metals and the detection of most valuables the highest DISC control setting that still responds to a USA nickel is ideal. This should occur somewhere between the RING RANGE "P" and the COIN RANGE "P".

III. For the rejection of all trash metals, even though some valuables will also be lost, higher rejection levels are useful. Some areas of severe trash can easily be searched for silver coins at high DISC settings. Nickels and small to medium gold items will not be detected.

All Metal Toggle Control

The ALL METAL toggle located on the handle selects between the two available operating modes. The center DISC position is used during most searching where the rejection of trash metals is desired. The temporary (squeezed and held) or forward LOCK positions are used to provide superior pinpointing, and for searching when

All Metal Toggle Control cont....

the desire is to detect all types of metals, particularly iron/steel. The temporary (squeezed and held) is the same as LOCK except it provides for temporary use.

I. During most searching the center DISC position is desired.

A. The DISC position allows the rejection of trash metals based on the DISC control setting.

II. For pinpointing or when iron/steel items are desired,

squeeze and hold the toggle on the handle or place it in the forward LOCK position.



A. When the ALL METAL toggle is in the temporary or LOCK position the instrument responds to all types of common metals. Note that some loop movement is required.



Attention:

To use your Classic® III in average conditions: Set the ON/OFF SENS (Sensitivity) knob to the "P" (Preset) position. Set the DISC knob to the RING RANGE "P" (Preset) position. Set the G.E.B./DISC (Ground Exclusion Balance/Discrimination) toggle (located on the handle/rod) to the center G.E.B./DISC position. Set the NORM/BLACK SAND toggle to the NORMAL position. Set the FREQ ADJ (Frequency Adjustment) to the "P" (Preset) position.

The loop must be in continuous motion (moving from side to side) in order for this model to respond to metals. If the loop is held stationary, metal may not respond.

A good metal (coin) will produce a smooth, consistent, solid sounding "BEEP". A trash metal (nail or steel bottle cap) will produce no sound or a rough, inconsistent, click or flutter-sounding "BEEP".

Pinpoint metals exact location by squeezing and holding the G.E.B./DISC toggle (on the handle/rod) in the temporary G.E.B. position and then slowly "X-ing" the loop over the area "eyeballing" the center. The detector will beep as the physical center of the loop passes the center of the target. Release the G.E.B./DISC toggle and it will automatically return to the G.E.B./DISC position before continuing to search.

**C
l
a
s
s
i
c

III**

Operating Instructions - Classic® III

I. Once fully assembled and the batteries installed: Set the ON/OFF SENS knob to the "P" (Preset) position. Set the DISC knob to the RING RANGE "P" (Preset) position. Set the G.E.B./DISC (Ground Exclusion Balance/Discrimination) toggle (located on the handle/rod) to the center G.E.B./DISC position. Set the NORMAL/BLACK SAND toggle to the NORMAL position. Set the FREQ ADJ (Frequency Adjustment) to the "P" (Preset) position.

II. The SENS (Sensitivity) knob turns the instrument ON/OFF and adjusts the responsiveness of the detector to metal targets as well as interference from external electrical sources and ground peculiarities.

A. In most conditions the "P" (Preset) position is ideal.

1. If interference becomes apparent (false signals or instability) reduce the SENS control (counterclockwise) until smooth, stable operation is restored.

2. If smooth, stable operation is noted at "P" (Preset), increasing the SENS control (clockwise) may increase detection depth so long as the ground is not extremely mineralized.

3. When not in use, turn the SENS (Sensitivity) knob fully counter clockwise until it clicks indicating the instrument is turned OFF.

III. The DISC (Discrimination) knob adjusts the level of rejection against trash metals. It is active only when the G.E.B./DISC toggle (located on the handle/rod) is in the center position.

A. The Ring Range "P" (Preset) is recommended for most general purpose searching. In this position, the detector will reject most iron and light foil and respond to most valuables including jewelry.

1. Positions lower (counterclockwise) than Ring Range provide even less trash metal rejection, to the point of detecting virtually all types of common metals except small iron and small stainless steel.

B. The Coin Range "P" (Preset) is optional. In this position, the detector will reject more trash metals including aluminum pulltabs. However, nickels and some jewelry will also be rejected.

1. Positions higher (clockwise) than the Coin Range will provide even greater degrees of trash metal rejection.

C. The most useful range on this control is between the Ring Range "P" and Coin Range "P" positions.

1. If when searching at the Ring Range "P" position you feel you are digging too much trash, adjust slightly toward the Coin Range and try again. Finding the lowest (furthest counter clockwise) position that eliminates the common trash metals in your area is important in order to find items of jewelry.

D. When a trash metal is being rejected, it will produce a shorter sounding beep that is typically inconsistent, a click or flutter-sounding beep. When a good metal is accepted it will produce a consistent, smooth, solid and longer sounding beep. Some trash metals, such as larger pieces of lead, brass, aluminum or tin will produce a good sound regardless of the DISC control position.

IV. Once either Ring Range "P" or Coin Range "P" has been selected, sweep the round loop close to the ground passing it from side to side. The loop must be swept (in motion) for metals to respond and provide accurate discrimination. Each pass of the loop from left to right (or from right to left) should take about two seconds. If the loop is swept very, very slowly or is stopped, the detector may not respond to metal.

V. At this point, it is a good idea to find an area relatively free of metal to practice. Place a coin on the ground. Pass the loop over the coin. Note that some loop movement is necessary to receive a good clean sound. Note that if you sweep the loop too slow the coin doesn't respond well.

VI. Now place a large nail, and/or a steel bottle cap (not aluminum) on the ground. Sweep the loop over these metals. Note the inconsistency in the beep, and that it is a shorter click or has a flutter to the sound. An operator will soon learn to ignore the clicks or flutter-sounds junk produces and listen for the smooth consistent beep coins and other good metals produce.

VII. Once a smooth consistent beep has been located, pinpoint exactly where to dig by squeezing and holding the G.E.B./DISC toggle (located on the handle) in the temporary G.E.B. position and "X-ing" the loop slowly over the area "eyeballing" the center. The detector will "beep" as the physical center as the loop passes the center of the target. Note that some loop movement is required. It is a good idea to place coins on the ground and practice pinpointing. It takes some time to develop pinpointing skills. Release the G.E.B./DISC toggle and it will automatically return to the center G.E.B./DISC position before continuing to search.

VIII. If the desire is to detect iron/steel such as tools, relics or property stakes, place the G.E.B./DISC toggle in the forward G.E.B. position and leave it there during searching. With the G.E.B./DISC toggle in the forward G.E.B. position, all types of common metals respond.

IX. If searching near other metal detectors, often cross talk or interference will result. Most often a static sound or unusual blare will be produced by your detector.

A. Simply turn the **FREQ ADJ** (Frequency Adjustment) knob slightly, until the static is eliminated.

X. For searching in extreme conditions, such as a wet salt water beach with black sand or any other high mineralization, the **NORMAL/BLACK SAND** toggle can be used to improve performance. Such extreme conditions normally hinder the detection depth of this type of instrument.

A. To deal with such conditions place the **NORMAL/BLACK SAND** toggle in the **BLACK SAND** position, place the G.E.B./DISC toggle in the center G.E.B./DISC position, and use a low DISC knob setting, **RING RANGE "P"** or lower (counterclockwise).

B. When setting the controls in this manner, the instrument will respond to all types of common metals. When the **NORMAL/BLACK SAND** toggle is in the **BLACK SAND** position, the entire DISC range is shifted above the **COIN RANGE "P"**. All trash rejection, except that against ground minerals, is concen-

trated above (clockwise of) the **COIN RANGE "P"**.

C. With the toggle set to **BLACK SAND**, increasing the DISC control setting above the **RING RANGE "P"** defeats the purpose of the **BLACK SAND** setting, and voids any performance increase in extreme conditions. Only at low DISC settings, **RING RANGE** or below (counterclockwise) will performance improve. It is not possible to use significant discrimination against trash in extreme conditions, while at the same time maintaining good ground penetration, with this type of instrument.

Sensitivity/Gain Control

The Sensitivity knob turns the instrument ON and OFF and adjusts the responsiveness of the instrument. As the **SENS** knob is turned further and further clockwise, detection depth as well as sensitivity to physically small metal items increases. Unfortunately, external electrical interference and ground interference also increases. The best setting is the furthest clockwise position that provides smooth, stable and predictable results.

An operator of the Classic® III may want to adjust the **SENS** knob for several reasons:

I. Minimum sensitivity is needed for detecting near power lines, electric fences, microwave antennas, etc.

II. For good results in most conditions the "P" (Preset) position works well.

III. If the "P" (Preset) position works well (smooth, stable and predictable results) increasing the **SENS** knob clockwise will increase detection depth so long as the ground is not extremely mineralized.

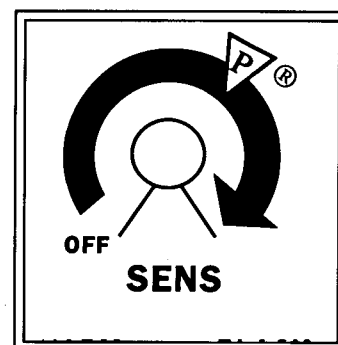

Discrimination Control

The DISC (discrimination) control selects the amount of rejection against trash metals. At the fully counter-clockwise position it has the minimum amount of discrimination

against trash metals.

Most common

metals are detected

at this setting except

for small iron and

small stainless steel.

As the Disc knob is

turned clockwise,

more and more trash

rejection is achieved.

At the fully clock-

wise position nearly

all trash metals are rejected as well as some valuables.

Regardless of the DISC knob position some larger

items, such as lead, aluminum and tin, will still

respond. The DISC knob is active only when the

G.E.B./DISC toggle (located on the handle/rod) is in

the center G.E.B./DISC position.

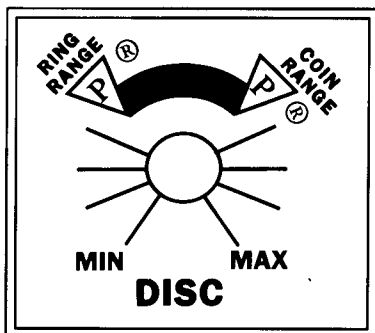

An operator of the Classic III® SL may want to adjust the DISC control for several reasons:

I. Minimum trash rejection is needed for detecting iron and steel such as tools, horseshoes, relics and property stakes. Iron and steels are rejected quickly as the DISC control is turned clockwise.

II. For the rejection of most common trash metals and the detection of most valuables the highest DISC control setting that still responds to a USA nickel is ideal. This should occur somewhere near RING RANGE "P" and the COIN RANGE "P".

III. For the rejection of all trash metals, even though some valuables will also be lost, higher rejection levels are useful. Some areas of severe trash can easily be searched for silver coins at high DISC settings. Nickels and small to medium gold items will not be detected at settings much higher than the RING RANGE "P".

G.E.B./DISC Toggle Control

The G.E.B./DISC (Ground Exclusion Balance/Discrimination) toggle (located on the handle/rod) selects

between the two available operating modes. The center G.E.B./DISC position is used during most searching where the rejection of trash metals is desired. The temporary squeezed and held or locked forward G.E.B. position is used to provide superior pinpointing and for searching when the desire is to detect all types of metals, particularly iron/steel. Squeezed and held is the same as locked forward except it provides for temporary use.

I. During most searching conditions the center G.E.B./DISC position is desired.

A. The center G.E.B./DISC position allows the rejection of trash metals based on the DISC control setting.

II. For pinpointing or when iron/steel items are desired, squeeze and hold or press forward to lock the G.E.B./DISC toggle in the G.E.B. position.

A. When the G.E.B./DISC toggle is in the forward G.E.B. position the instrument responds to all types of common metals.

III. Squeezed and held temporarily offers all the advantages of the locked forward G.E.B. position, only once released the toggle automatically returns to the center G.E.B./DISC mode.



FREQ ADJ (Frequency Adjustment) Control

Because metal detectors often operate at the same frequency, cross talk or interference often results when two or more detectors are operated close together. The FREQ ADJ (Frequency Adjustment) eliminates this interference by allowing you to change the operating frequency of the Classic® III.

I. When another detector is near, if static or an unusual

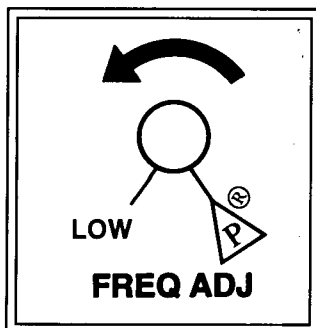

blare is noticed coming from your detector, slightly adjust the FREQ ADJ knob until the static is eliminated.

II. At "P" (Preset), the normal operating frequency of the Classic® III SL is approximately 6.55Khz.

A. As the FREQ ADJ knob is turned operating frequency can be shifted to 6.35Khz.

1. This degree of frequency shift is more than adequate to eliminate interference from most metal detectors.

of the BLACK SAND feature. Only when the BLACK SAND position is used in combination with the center G.E.B./DISC toggle position, and a DISC setting at or below RING RANGE "P", will performance in extreme conditions improve.

NORM/BLACK SAND Toggle Control

The NORM/BLACK SAND toggle allows an operator to switch between two different discrimination ranges #1 NORM which is best suited for normal conditions, #2 BLACK SAND which is best suited for extreme conditions such as black sand, saltwater beaches or other high ground mineralization. The BLACK SAND position allows for true zero discrimination which will provide superior penetration in such extreme conditions.

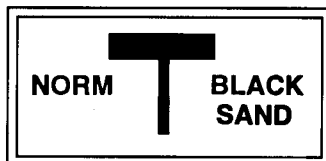

I. For most searching conditions the NORM position provides good performance.

II. If searching extreme conditions, use the BLACK SAND position, with the G.E.B./DISC toggle in the center G.E.B./DISC position, and the DISC knob set at RING RANGE "P" or below (counterclockwise).

A. When set in this manner all types of common metals will be detected, however, ground penetration will be improved.

B. Using the BLACK SAND position, with DISC knob settings above RING RANGE "P" defeats the purpose





***T
e
c
h
n
i
q
u
e
s***

Search Methods

I. Loop Sweep

A. Because the loop must be moving in order to accurately respond, the sweep of the loop is critical to performance. Sweep the loop close to the ground. Keep it close throughout the sweep. (See examples.)

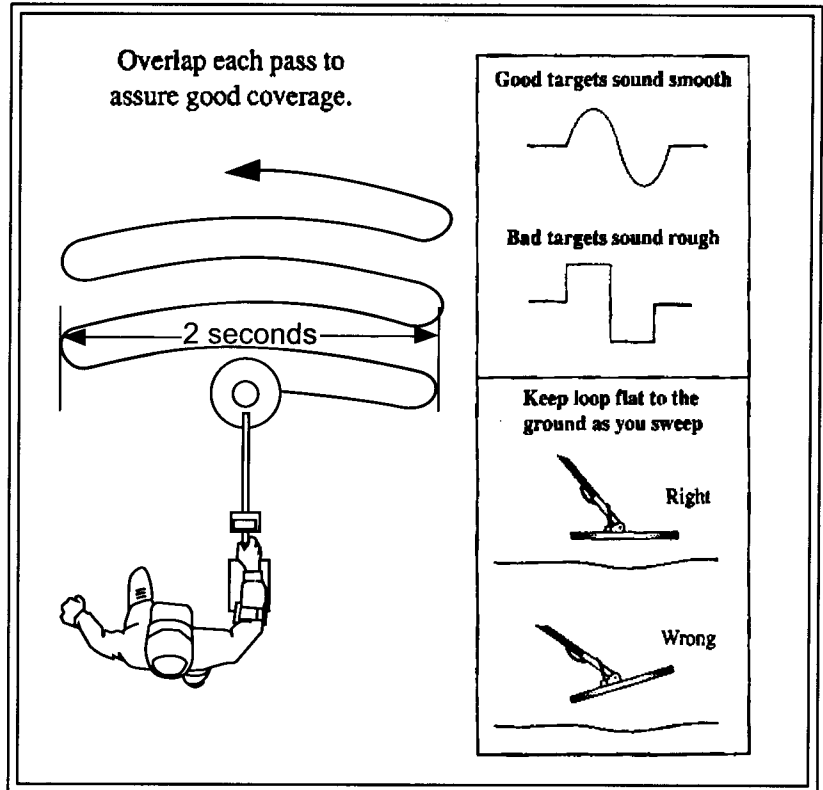

B. Productive areas, or areas that have potential, should be searched from at least two different directions, at ninety degree angles from each other.

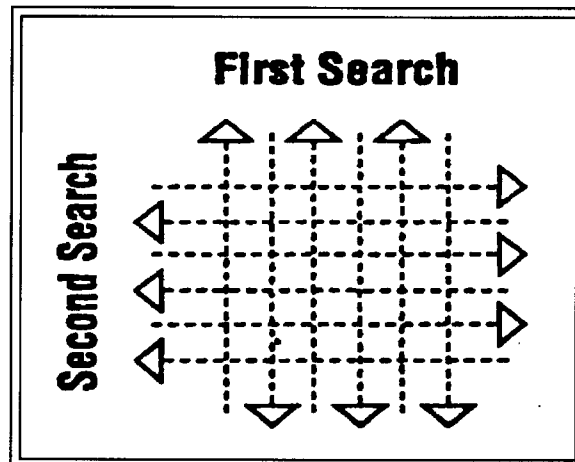

II. Pinpointing

A. Once a consistent good sound is located, "X" the loop over the area slowly to pinpoint the exact center. With Classic® II and Classic® III models squeeze and hold the G.E.B./DISC toggle (located on the handle) or press it forward to lock and "X" the area slowly to pinpoint the exact center. The detector will beep as the physical center of the loop passes the center of the target. Listen for the loudest beep as you sweep the loop over the area, then stop and sweep in the other direction listening for the loudest beep. Where the two loudest beeps intersect is the center of the target. Return the G.E.B./DISC toggle to the center G.E.B./DISC position before continuing to search.

IV. Where To Search

A. Start with your own yard. Valuables can be found anywhere people have congregated, gathered, lived, sat, walked, played, camped, picnicked, traveled or fought.

B. Any area inhabited before 1965, is likely to have the older styles of collectable coins.

V. How To Search

A. You must have permission to search private property from the owner or person in charge of managing the property. In most cases, you can locate the owner through City Hall or the County Seat.

B. If the area is City owned contact the Parks and Recreations Department. If it is a State or Federal Park contact the superintendent or grounds keeper. In most cases permission to search is not a problem, given a few restrictions, such as known and marked historical parks.

III. Digging

A. Care must be taken to use the appropriate digging tool for the terrain, and not to leave unsightly excavations or holes on other peoples property.

B. There are hundreds of digging tools designed to minimize the impact removal of small items has on the grass and vegetation, and avoid damaging the items found.

C. Sand scoops are all that is needed in some areas, in others a hand gardening spade. Challenging ground conditions may require more sophisticated tools. Check with your Dealer regarding an appropriate tool for your area.

Headphones:

Optional headphones are available for this model. The Classic® models come equipped with a 1/4 inch stereo headphone jack. It is located below the elbow cup, above the battery compartment. Most 1/4 inch headphones from 8-120 ohms will work with this model. White's has several high quality sets to choose from with volume controls for winter or summer use.

As the Classic® models do not have volume controls, if you have sensitive hearing be sure to select headphones with volume controls.

Headphones are recommended for the following reasons -

- A. Increase battery life.
- B. Increase the operators ability to hear the metal target.
- C. Provide the operator privacy.
- D. Keep the detector noises from annoying less enthusiastic bystanders.
- E. Full-size headphones block external noise, such as traffic or surf.



Proper Care

I. Cleaning

A. Both the loop and rod are waterproof and can be cleaned with fresh water and mild soap. The control box is not waterproof and must be kept dry. Never lift a wet loop above the height of the control box as water can run down the inside of the rod damaging the electronics. A damp cotton cloth can be used to wipe off a dirty control box.

II. Weather

- A. Do not expose your detector to the conditions of a car trunk during winter and/or summer extremes.
- B. Protect it from direct sunlight during storage.
- C. The control box is rain resistant. However, it must be protected from heavy rain.

III. Saltwater

A. Saltwater is very corrosive! After your detector has been exposed to salt, rinse the loop and rods in fresh water. Wipe down the control box with a damp cotton cloth. Do not allow water inside the control box and avoid lifting the loop above the height of the control box.

IV. Storage

- A. When the instrument is not in use, make sure the knob is turned fully counterclockwise, to the OFF position.
- B. If you plan on storing your detector for long,, remove the battery holder from the instrument and remove the batteries cells from the holder.
- C. Store the instrument indoors, in an area where it will be protected from abuse. Over the years White's has noted more service repairs and physical damage, on units in storage than those experiencing daily use.

V. Additional Precautions

- A. Avoid dropping your detector while attempting to set it down to dig.
- B. Avoid using your detector for leverage when standing up from a dig.
- C. Do not use any lubricants, such as WD-40, on any part of your detector.
- D. Do not modify your instrument during its warranty period

Advanced Operator

Ground Rejection

The ground rejection of the Classic® models is factory preset at a level slightly positive of a ferrite mineral sample. This setting will provide good performance in most ground conditions.

If you notice a lot of false targeting (beeps where there are no metal items) or if ground penetration is less than several inches, the ground rejection may need to be adjusted for your area.

Some areas will not allow good ground rejection, such as wet salt water beaches or black sand. In these areas, it is advisable to leave the ground rejection alone and work the detector with the NORM/BLACK SAND toggle in the BLACK SAND position, using the G.E.B./DISC toggle in the center G.E.B./DISC position, and a low DISC knob setting (RING RANGE or below).

To reset the ground rejection:

I. Place the G.E.B./DISC toggle in the center G.E.B./DISC position and abruptly lower and lift the loop from the ground. A beep indicates ground rejection is not set perfectly.

II. Under the grommet on top of the instrument, there is an access hole with a trimmer inside.

III. Use a very small regular head screwdriver to very slightly adjust this trimmer.

A. Find the edge where in one direction the detector beeps as the loop is abruptly lowered and lifted from the ground and in the other direction the detector doesn't beep as the loop is abruptly lowered to and lifted from the ground.

B. The correct setting is the point or edge where the detector just stops beeping as the loop is abruptly lowered to and lifted from the ground. Going further into the silent area in most cases hinders performance.

C. Cover the access hole with the decal or a small section of black electrical tape to prevent moisture and dirt from entering the control box.

Discrimination:

The DISC (discrimination) control can be further labeled with information that will aid in determining if a metal is trash such as a pulltab, or good such as jewelry. Use the center G.E.B./DISC toggle position.

I. Obtain a USA nickel, and an ordinary (common) aluminum pulltab with tail.

II. Bury the nickel about an inch deep in the ground.

A. Sweep the loop over the nickel while adjusting the DISC control. Note that if the DISC control is turned too high the nickel is rejected.

1. Find the furthest clockwise DISC setting that still detects the nickel well, and mark this position on the control.

III. Now do the same thing with the pulltab. Bury it an inch in the ground.

A. Sweep the loop over the pulltab while adjusting the DISC control, note the point the pulltab is rejected.

1. This time, mark the furthest counterclockwise position that rejects the pulltab.

IV. If completed correctly, you should now have two marks on your DISC control.

A. Furthest point (clockwise) a nickel is accepted.

B. Furthest point (counterclockwise) a pulltab is rejected.

C. Note that if the marks for nickel and pulltab are very close together, the pulltab is probably not ordinary. Try a different, more common pulltab.

V. You're now ready to search.

A. Use the DISC position you marked for accepting a nickel.

B. Once a consistent, smooth, solid beep is found continue sweeping the loop over the target while slowly turning the DISC control clockwise.

1. If the target starts rejecting prior to the pulltab mark, it is likely a nickel or jewelry.

2. If the target is rejected at the pulltab mark, it is likely a pulltab.
3. If the target is not rejected until well after the pulltab mark, it is either large jewelry, large aluminum foil, or an aluminum screw cap.
4. If the target is not rejected all the way to the fully clockwise DISC position, it is likely a coin other than a nickel.



Visit our site on the World Wide Web

***<http://www.whites.co.com>
for the latest information on products, services, local dealers
and treasure hunting news.***

Glossary Of Detecting Terms

AC (Alternating Current) - Metal detector modes that require loop motion to respond to metal.

Air Test - Testing a metal detector's response to various metallic samples with the loop held away from the ground.

All-Metal - Describes any mode or control setting allowing total acceptance of all types of metal targets, iron and non-iron.

Audio Identification - Circuitry or mode producing different audio tones (pitches) for different target types.

AutoTrac (Automatic Ground Tracking) - A feature that continually and automatically readjusts the ground balance (ground rejection) of a metal detector during searching.

Back Reading - A false target response caused by either overloading due to a very strong target near the loop, or a rejected trash target very close to the loop.

Black Sand - One of the most extreme components of nonconducting negative ground mineralization. Also called (Fe₃O₄), magnetite, iron oxide, magnetic sand.

Cache - Intentionally buried or secreted hoard of valuables.

Conductive Salts - One of the major mineral types which makes up the positive ground matrix. Wet ocean salt/sand will produce a positive indication much like a metal target.

Conductivity - The measure of eddy currents of electricity that generate on a metals surface.

Custom Program - Feature choices on a computerized metal detector that are then saved or stored for future use.

DC (Direct Current) - Used to refer to metal detector modes that do not require loop motion to respond to metal targets.

Detection Pattern - The shape of the electromagnetic detection field generated by a metal detector's loop.

De-tuning - A method of narrowing a target signal's width and length for precise pinpointing.

Depth - How deep a detector can respond to metal targets.

Depth Reading - Feature that indicates how deep a target is in the ground before digging.

Discrimination - Adjustable feature that can ignore or respond to different metal types based on their ampli-

tude and phase. Used to cancel responses of unwanted trash metals.

Drift - A loss or increase in threshold caused by the passage of time or variations in temperature.

Eddy Currents - Small circulating currents of electricity on the surface of metals produced by external electromagnetic fields.

Electromagnetic Field - An invisible force extending from the loop created by the flow of alternating oscillator frequency current around the transmit winding.

Elliptical Coil - A loop with an ellipse (oval) shape.

False Signal - Erroneous signal caused by non-metal items.

Faraday Shield - Conductive coating inside loops, loop cables, and control housings to eliminate electrostatic interference.

Ferrous Oxide - Decomposed particles of iron (mineralization).

Frequency - The number of complete alternating current cycles produced by the transmit oscillator per second. Measured in Hertz (Hz) or cycles per second.

Frequency Shift - Changes the operating frequency suppressing the interference (cross talk) between detectors.

Fringe Target - A target so deep or so small as to be barely detectable with a metal detector.

Ground Balance - A feature that can be adjusted to ignore the masking effect ground minerals have over metal targets.

Ground Matrix - Total volume of undisturbed ground, usually contains varying amounts and combinations of minerals, moisture, and salt. In an undisturbed condition the ground matrix can exhibit numerous phenomena regarding metal detector performance.

Hipmount - A configuration where the control box of a metal detector is mounted on the operators hip limiting the weight one has to sweep to that of the loop and rod assembly.

Hot Rock - A rock that contains a higher concentration of minerals than the surrounding ground.

Interference - Hinderance of performance due to sources outside a metal detector causing static and unwanted or false signals.

LCD (Liquid Crystal Display) - A digital display used for graphic visual indications as an alternative to the use of meters.

Memory - A computerized metal detector's ability to retain operator selected settings for future use.

Menu - A display screen that allows the operator to choose among different features.

Metal - Metallic substances: iron, foil, nickel, aluminum, gold, brass, lead, copper, silver, etc.

Meter - An analog component which provides visual indications regarding a metal target (Alternative to LCD displays).

Mineralized Ground - Any soil or sand that contains conductive and/or magnetic components (minerals).

Mixed Mode - A special metal detector mode that combines all metal and discriminate features into one operating mode.

Mode - A condition or feature of operation selected by the operator for specific functions.

Motion Instrument - A detector type that requires search loop movement to activate the signal from a metal target.

Microprocessor - An electronic component (chip) that can be programmed to perform a variety of functions and control a variety of features.

Negative Ground - Soil containing mostly magnetic minerals.

Neutral Ground - Soil that contains no significant minerals.

Nicad (Nical Cadmium) - A battery type that can be recharged.

Non-Ferrous - Not of iron. Metals of the precious and semi precious class (i.e. aluminum, brass, lead, gold, silver, copper).

Non-Motion - Mode that will respond to metals with or without movement of the loop.

Notch Discrimination - Discrimination circuitry that allows an area of the discrimination range to be accepted or rejected independently of the remaining discrimination range (a window of acceptance or rejection within the discriminate range).

Notch Width - Finite range of a notch discrimination setting (how wide of window is accepted or rejected).

Null - A decrease in sound caused by rejection of targets or ground mineralization.

Oscillator - An electronic component or circuitry designed to generate a specific rate of current frequency to power the loop's transmit winding.

Overlap - Advancing each sweep of the loop in small increments to insure good area coverage. Each sweep should overlap the last by at least 50%.

Overload - Occurs when the receiver of a metal detector becomes overwhelmed due to too much signal (ground and/or target).

Overshoot - A false signal heard as the loop passes over a rejected target when using a non-motion discriminate mode in combination with automatic tuning (**S.A.T.**). Excessive tuning restoration pushes the audio above the threshold level creating a positive response at the edges of target detection.

Phase - The length of time between eddy current generation sustained on a metals surface and the resultant secondary electromagnetic field effect on the loops receive winding. Relates to target conductivity.

Pinpointing - Finding the exact target location with respect to the loops physical center.

PI (Pulse Induction) - A type of metal detector circuitry that operates differently than the standard Transmit Receive or Very Low Frequency instruments. Primarily recommended for better results in salt water.

Positive Ground - Soils that contain conductive components such as salt.

Preset - A control setting or marking determined to work well for average conditions.

Preset Program - A selection of a computerized metal detector that automatically selects all the features suited to a particular type of searching condition.

Prospecting - Searching for gold in its natural state (nuggets).

Rejection - Non-acceptance or cancellation of a target response by discrimination circuitry.

Relic - An artifact of the past.

S.A.T. (Self Adjusting Threshold) - Automatically resets the threshold to correct for any minor ground, temperature, or electrical changes that typically cause threshold variations.

Scrubbing - Sweeping the loop with contact to the ground.

Searchcoil - (See Loop)

Sensitivity - Measure of a detector's ability to respond to targets within the detection pattern. Usually indicates the capability to respond to small targets rather than maximum detection depth.

Signagraph - A graphic display of a pattern characterizing a targets electrical and/or magnetic properties.

Signal - An audio response or visual indication alerting the operator that a metal target has been detected.

Silent Search - Capability of a metal detector to respond to metals without a threshold or background sound being heard continually during searching.

Stability - The ability of a metal detector to maintain smooth operation without interference or unstable motion employed in moving the loop over the ground.

Target - Any object that causes a metal detector to respond.

Target Masking - When large size or high concentrations of trash metals, or extreme ground mineralization, drive the threshold into the null zone suppressing weaker positive responses.

Ten-Turn Control - A control knob which can be rotated ten times to cover the full electrical range of the feature.

Test Garden - A mapped plot of buried targets at various depths to aid in learning the characteristics of a metal detector.

TH'er, TH'ing - Universal word contractions for treasure hunter and treasure hunting.

Threshold - The background hum heard continually during the use of a metal detector indicating the most sensitive audio.

Tone Control - An adjustment for audio frequency or pitch.

Touch-Pad - Switches encapsulated in plastic or that allows the operator to select different functions or features.

Transmit Coil - A coil of wire inside the loop that creates the primary electromagnetic field.

TR (Transmit Receive) - Term used to describe early metal detector technology. Usually describes non-ground rejecting detectors or modes.

Two Box - A metal detector that has the transmit and receive coils mounted in separate housings. By enlarging and separating the transmit and receive coils great depths regarding large metal items can be achieved. Also called cache detectors.

Viewing Angle - A liquid crystals display adjustment for contrast allowing optimum visibility for various light conditions.

Visual Discrimination - The ability of a metal detector to determine trash or non-trash by means of visual indications.

Visual Discrimination Indication (VDI) - A visual indication as to the type of target a metal detector is detecting.

VLF (Very Low Frequency) - Generally used to refer to metal detectors that can cancel the effects of ground mineralization, typically with operating frequencies in the 3-30 kHz range.

VLF/DISC - A detector that can cancel ground mineralization while at the same time discriminate against trash.

Voltage Regulator - Circuitry that controls the amount of electricity supplied to operate a metal detector with no loss in performance over a specific voltage/current range.

Zero Discrimination - Used to describe detectors whose discrimination control allows the acceptance of all types of metals when set to the zero position.

Customer Service -

White's reputation has been built on Quality Products backed by Quality Service, not only Before but After the Sale, and is the cornerstone of our Customer Relations.

Before shipping detectors for service:

A. Contact your Dealer or White's Scotland Service Department. Telephone ++44 (0) 1463 223456.

B. Double check the obvious, such as batteries, and try the detector in another area to be sure there is not interference.

C. Be sure to send all necessary parts with your detector, as any one of the following items could give rise to symptoms - Control Box, SearchHead, Rechargeable Batteries (if used), Dry Cell pack.

D. Always include a letter of explanation about your concerns, even if you have talked to your Local Dealer or service department.

E. Take care in packaging instruments for shipping. Always insure your package.

White's (UK) Ltd. Limited Warranty Statement

If within two years (24 months) from the original date of purchase, your White's detector fails due to defects in either material or workmanship, White's Electronics (UK) Ltd. will repair or replace at its option, all necessary parts without charge for parts or labor.

Simply return the detector to our factory in Inverness, Scotland, giving details of the faults.

Items excluded from this warranty are non-rechargeable batteries, and other accessories.

The warranty is not valid unless the Warranty Registration Card is returned to the factory address within 10 days of the original purchase for the purpose of recording that date, which is the actual commencement date of the warranty.

This warranty does not cover damage to the detector caused by accident, misuse, neglect, alterations, modifications or unauthorized service.

Duration of any implied warranties (e.g., merchantability and fitness for a particular purpose) shall not be longer than the stated warranty.

Neither the manufacturer nor the retailer shall be liable for any incidental or consequential damages resulting from defects or failures of the instrument to perform.

This warranty does not affect your statutory legal rights.

THE SERIAL NUMBER WHICH IS UNIQUE TO YOUR UNIT IS ON A WHITE LABEL INSIDE THE BATTERY COMPARTMENT. PLEASE QUOTE THIS NUMBER ON ANY CORRESPONDENCE REGARDING YOUR DETECTOR.

White's Electronics has always been concerned with the absolute quality of their mineral/metal detectors. Service after the sales is of extreme importance to us and we always do our utmost to ensure that customers are satisfied with our units. If your unit should require servicing or repair, simply return it to us at the factory in Inverness and we shall carry out the necessary work for you. Any work carried out by unauthorized persons will automatically nullify the warranty.

If your unit requires repair, then return it to -

White's Electronics, (UK)Ltd
35J Harbour Road
Inverness IV1 1UA
Scotland, UK

Warranty Transfer Information

If for any reason you should sell your Classic® metal detector prior to the date the warranty expires, the remaining warranty is transferable.

Simply fill out the following information seal it in a stamped envelope, and send it to **White's Electronics, (UK) , 35J Harbour Road, Inverness, Scotland IV1 1UA**. They will then advise what warranty, if any, is available.

The Warranty Statement applies to both the original owner as well as the second owner.



Warranty Transfer

Original Owner:

Name: _____

Address (Which appears on the original warranty card):

Instrument Serial Number: _____

Original Purchase Date: _____

New Owner:

Name: _____

Address: _____

Comments: _____

Distributor Authorization Code: _____

